



TRANSPORTRANGE
JUNE 2023



GB

INNOVATIVE BY TRADITION

The name Fliegl has a decades-long reputation for quality, innovative action, and practical solutions for agriculture. These are advantages which have made Fliegl the No.1 In Europe, for example in the agricultural trailers sector. Whether it's for tippers, original push-off trailers, slurry technology or harvest logistics:

FLIEGL ALWAYS HAS THE OPTIMUM TRANSPORT CONCEPT FOR YOU.



GERMAN QUALITY USED WORLDWIDE

Despite globalisation, Fliegl has consistently carried out its development and production in Germany. One reason for this is the specially qualified personnel. From engineers to apprentices, we look for skills that we can develop through special further education and training. Another factor is the high technical standard existing in Germany, These are the ideal conditions for transforming our ideas into the high-quality products that people expect from the Fliegl brand.

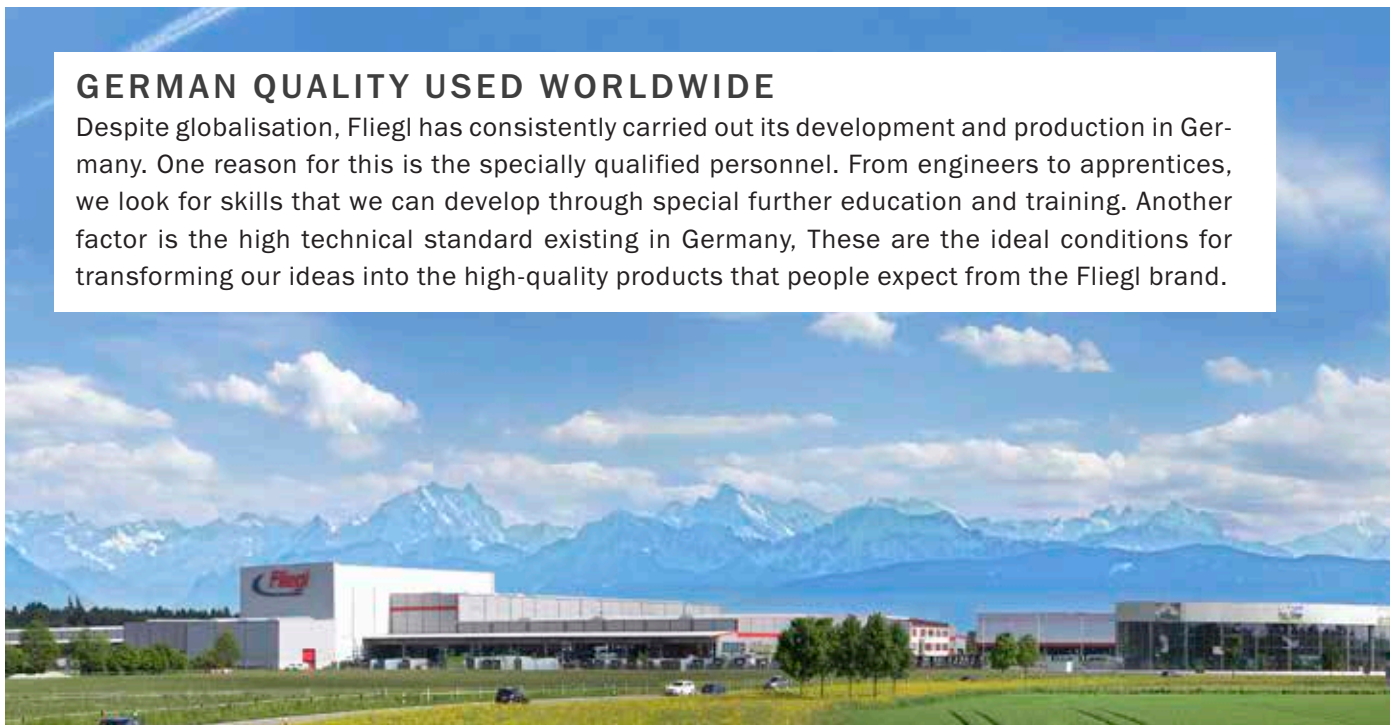

CONTENTS

ASW push-off trailer	5-33
Spreading systems	35-57
Spreaders for ASW	36-41
ADS single-axle spreader.....	42-47
KDS chain manure spreader.....	48-57
Three-way tippers and dumpers	59-95
EDK single-axle three-way tipper	60-63
Two-axle/three-axle three-way tippers	64-69
TDK tandem three-way tipper	70-75
EDK/DK/TDK technical data	76-79
TMK/TMK Profi dumper.....	80-87
TMK technical data.....	88-89
Transport technology	91-103
Hook lift	92 - 95
Platform trailers	96 - 99
Transfer trailers	100-101
TTW livestock trailer	102-103





ASW PUSH-OFF TRAILER



The Fliegl push-off trailer: the original!

The advantages over other systems:

- ⊕ Up to 5 times faster unloading time
- ⊕ Up to 60 % more load volume by compaction (depending on the material)
- ⊕ The extremely robust Fliegl push-off system is also perfect for heavy goods
- ⊕ Can be combined with a spreading unit in a few minutes



Optional: 300 mm extensions for additional volume and less waste.

about 60%
more load capacity



Pushing off, not tipping - so no problems even in low buildings.



Sealing strips: Special polyurethane strips arranged at a 45° angle seal the loading area perfectly.



Advantageous centre of gravity with the low design



One push-off trailer - many possibilities

The “Gigant” push-off trailer is ready to work for you all year round. For example, whether it’s grass or maize silage, potatoes, large bales, heavy materials or snow – its flexibility and pushing power are boundless.



Spreading unit PROFI V2 with thrower discs and slinger



Overloading auger ÜLS 400 for grain
Overloading rate about 7.5to/min



Perfect for carrying snow,
materials do not stick

The possible applications - all year round

Area of application	January	February	March	April	May	June	July	August	September	October	November	December
Grass silage												
Maize silage												
Grain maize												
Grain/rape												
Sugar beet												
Potatoes												
Manure												
Compost												
Bale transport												
Wood chips												
Pallet transport												
Gravel												
Snow												



“PomOver” potato overloading belt



“MobilFast” overloading belt
(up to 30m³/min)



RUBY overloading belt for sugar beet
Overloading rate approx.: 15m³/min

Cover systems

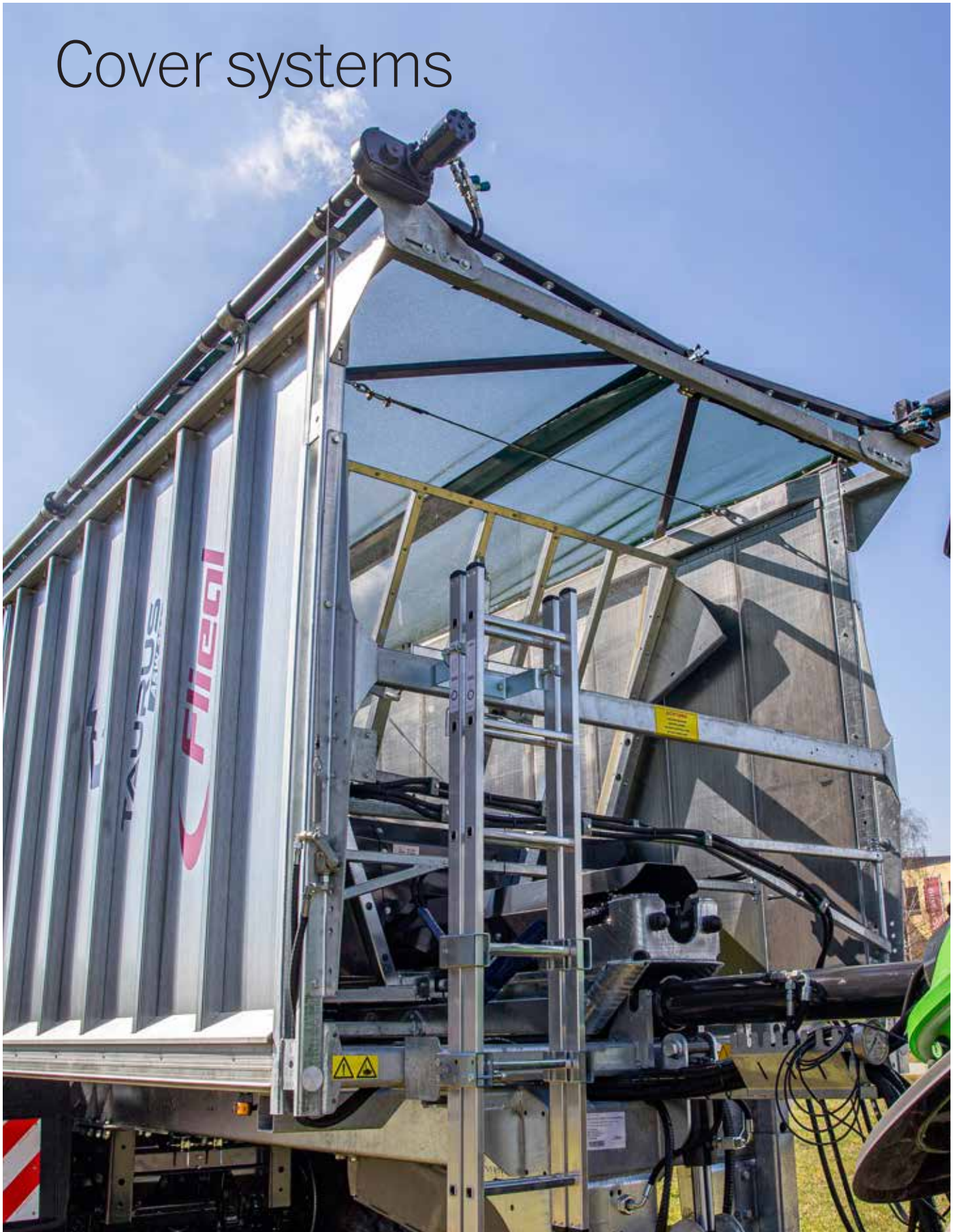

“SPEEDCOVER” COVERING NET



Winds up by spring tension



Protection guard to prevent dirt and damage

Hydraulic oil motor to pull in the covering net

- Suitable for almost any trailer
- Does not obstruct the loading area

THE FLIEGL “TOPLIFT” LIFTING ROOF AND »TOPLIFT«



TOPLIFT LIGHT:

Cover net folds up to the side



TOPLIFT: The two tarpaulin halves can be opened and closed in the shortest time

SLIDING TARPAULIN



- For covering the loaded goods quickly and simply - can be operated from the ground!
- Protection from water
- Available for all push-off trailers and Bull dumpers up to 10.10 m length

Semi-trailer ASS 298 AGRO TRUCK

In aluminium- or steel versions

- Capacity up to 60 m³
- Two-axle version
- Air suspension
- Steering axle with automatic locking
- 60 km/h version with EBS
- Electromagnetically controlled two-line hydraulics required on the truck



Optionally available with various cover systems





ASS semitrailer

The Fliegl push-off semitrailers transport bulky and heavy goods and can unload them in a matter of seconds. Be it wood chips, pellets or grain the push-off technology ensures smooth and complete emptying. During the unloading process, the push-off mechanism offers excellent stability.





ASS 388 steel version with special painting of rear panel



ASS 398 GREEN-TEC



ASS 2108 steel

The “AGRO TRUCK” BODY

Truck body in aluminium and steel versions

- Load volume from 35 m³ to 50 m³
- Optional electromagnetic control
- Optional mounting on truck chassis

AGRO TRUCK body for various truck chassis

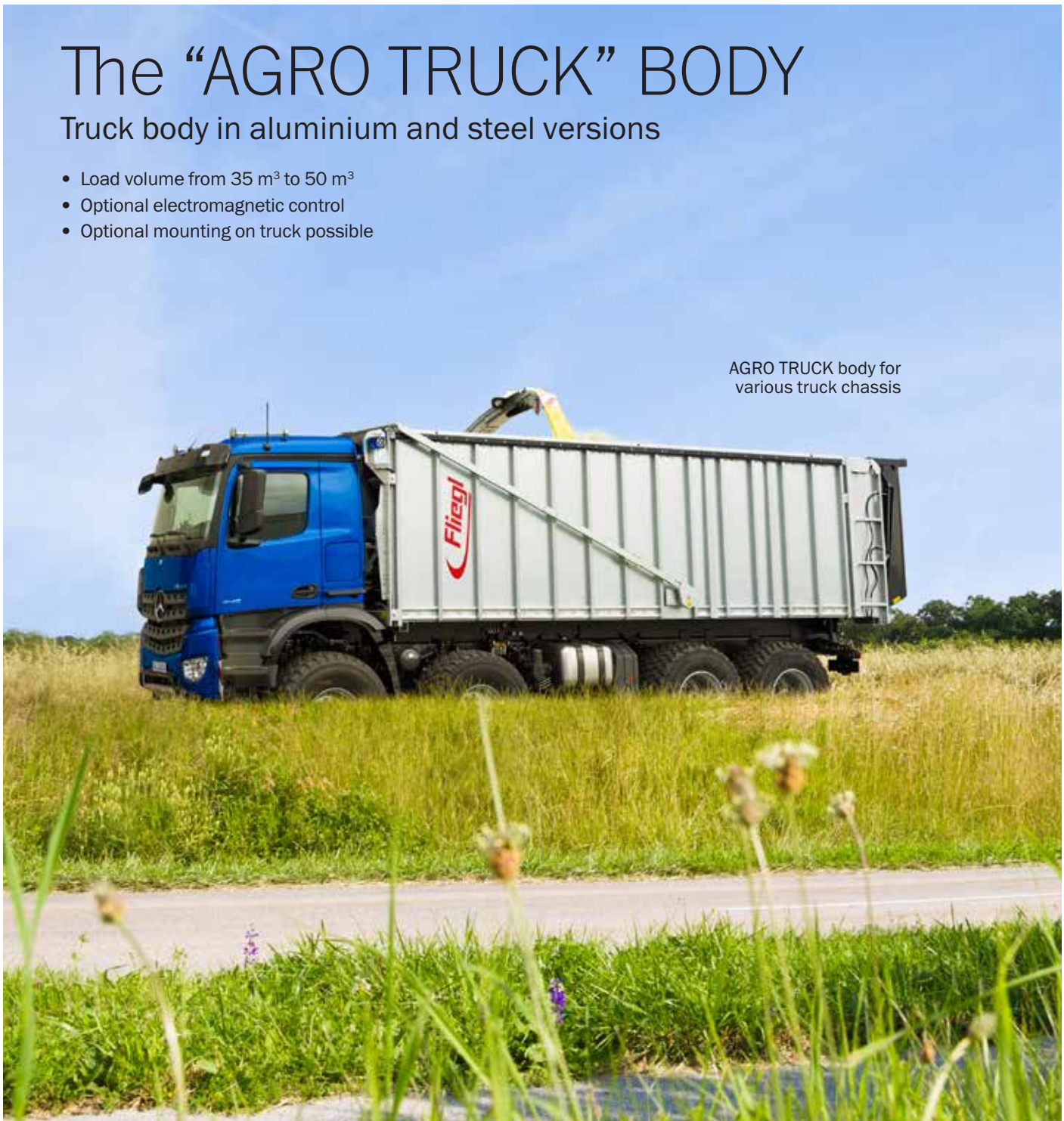

Dolly systems

Modern transport technology and transport logistics are the logical answer to ever-growing harvest outputs and longer and longer transport routes.

- One-axle dolly with 10.5 t coupling load and 12.5 t total weight
- Tandem dolly with 17 t coupling load and 20 t total weight
- Optionally with air suspension (raising and lowering)
- Mechanically adjustable fifth wheel plate as standard, hydraulically as option

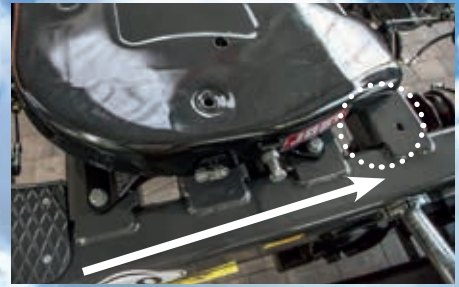

Mechanically adjustable fifth wheel plate for one-axle and tandem dolly



Bordhydraulik mit Gelenkwellenantrieb - optional

ASW Taurus

The transport giants with outstanding equipment.

Capacity from 35 m³ to 55 m³

ASW Taurus 391

Optional: Fliegl »TOPLIFT LIGHT« lifting roof



Optional: hydraulic forced steering

ASW Taurus 3101





ASW Taurus 281



ASW Taurus 271



The Taurus comes with comprehensive additional equipment as standard

- Protect package
- From ASW 281: 2.30 m side walls
- „Dynamic“ full-LED rear light
- 650/55 R 26.5“ tyres
- Underride guard, hydraulically folding
- Fully galvanised hollow section frame
- BPW hydr. suspension
- Hydraulically sprung draw gear
- Bei ASW 281/391 und 3101 410 x 180 Bremstrommel
- Lenkachse
- Untenanhängung K80
- Steigleiter

Overloading augers

Fliegl overloading augers for maximum output in the transport logistics



Simple installation on all ASW types

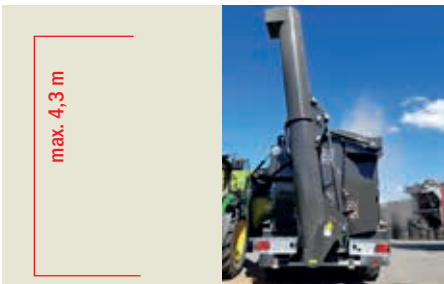

OVERLOADING AUGER TYPE 500

Overloading pipe with \varnothing 500 mm
Folds hydraulically.
Overloading height from 4.30 m (depending on tyres).
Overloading rate about 10 to / min



OVERLOADING AUGER TYPE 400

Overloading pipe with \varnothing 400 mm
Folds hydraulically.
Overloading height from 4.30 m (depending on tyres).
Overloading rate about 7.5 to / min



Hydr. sliding gate allows the overloading auger to be completely emptied when loaded



Dosing roller with 3 horizontal milling drums

Potatoe- and beet harvest

OVERLOADING BELTS »RUBY« AND »POMOVER PLUS«



OVERLOADING BELT "POMOVER PLUS"

Hydraulically folding overloading and cleaning belt "POM-Over" with cleaning rollers, e.g. for potatoes, carrots etc.



Cleaning rollers

RUBY

SUGAR BEET OVERLOADING BELT "RUBY"

Create beet clamps with "loading-ready" width and height. Can also load onto trucks.

- Higher output at the sugar beet harvest by bunkering while lifting the beet
- Makes the harvesting work easier with large plot lengths especially where the bunker volumes lifted are too low
- Tidy clamping system
- Overloading onto truck trailers
- Unloading rate up to about 750 tonnes / hour (depending on loading height)
- Unloading height adjustable hydraulically between 1.70 and 4.00 metres
- Emptying rate up to about 15 m³/min
- Soil-saving tyres - different variants to choose from - for low ground pressure, low drag resistance and low fuel consumption
- Convenient electro-hydraulic operation



Trucks can be loaded in the shortest time

The Fliegl swap system



Cylinder for hydraulic lifting gear

Starting with the ASW 256 GIGANT push-off trailer, the chassis fitted as standard will be swap-body chassis. Your push-off trailer is thus a true all-rounder.

Due to the standard container locking the Push-Off Trailer can be fitted on any container trailer. On request also available as hook-lift trailer.

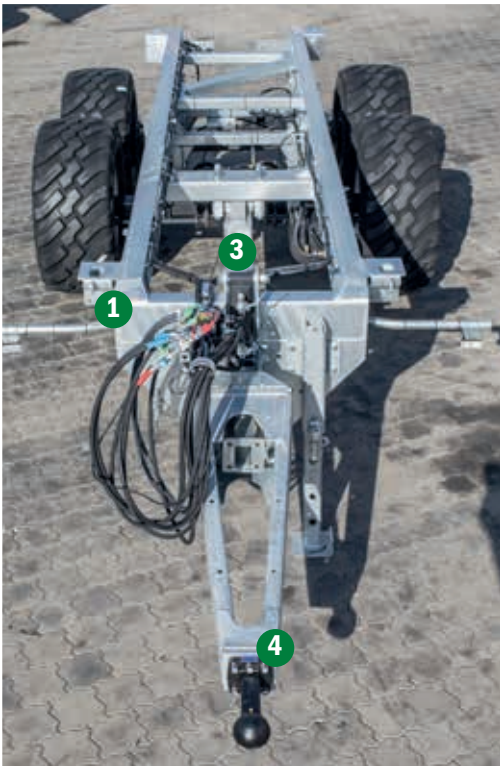

- 1 Swap chassis
- 2 Pre-fitted for PTO through-drive (spreading unit or overloading auger)
- 3 Hydraulic drawbar suspension
- 4 Swivelling drawbar for upper or lower hitch as standard

Chassis technology

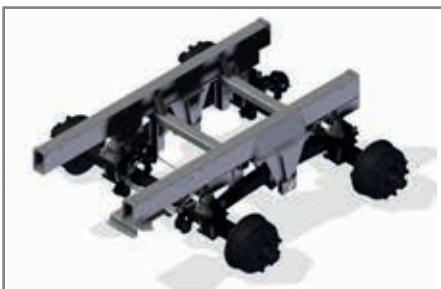

Titan tandem assembly for best ground adaptation



Hydraulic axle suspension



Air suspension



»Gigant«



»Gigant Plus«

Top/bottom hitch

With the swivelling drawbar, it is easy to change from top to bottom hitch.



Bottom hitch ...



... swivels for top hitch

BPW axle



Gelenkt



Geradeausfahrt

BPW steering axles with wave-form thrust bearings. They keep the wheel straight ahead when driving straight and turning, with the lateral forces on the tyres pressing the thrust washers over one another. After the turn the straight setting is automatically restored by the weight of the vehicle.



Underride guard



Germany 40 km/h version with fixed underride guard



Optional: Mechanical folding underride guard

Hydraulic underride guard



When the large-area back wall opens, the underride guard folds up automatically

Mechanical forced steering*

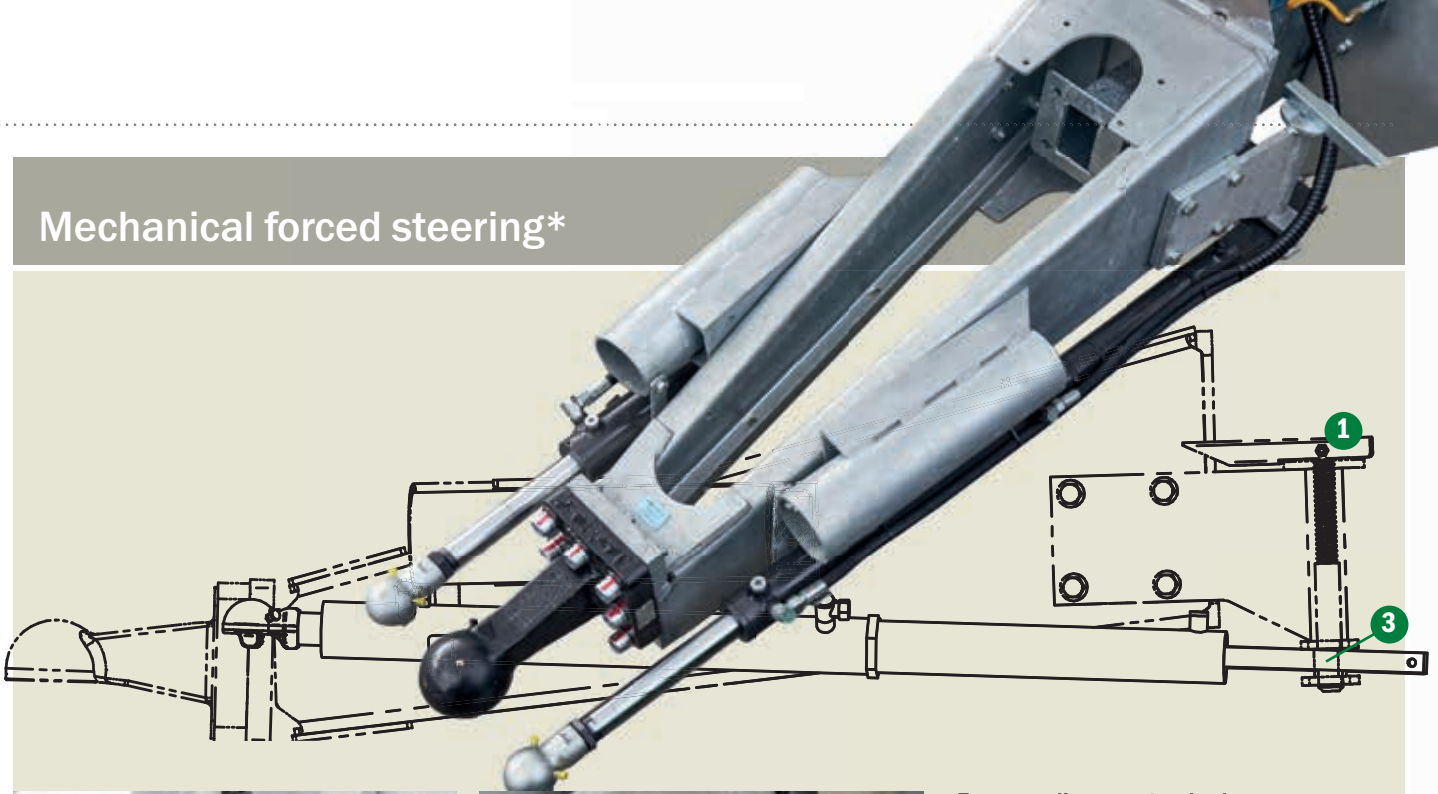

Easy coupling - as standard

- 1 Open the locking pin on the forced steering cylinder
- 2 Simple hitching of the K50 coupling on the tractor
- 3 Fix the locking pin



3 Fix the locking pin

The dimensions and clearances at the K80 ball head coupling must comply with the ISO 500 and ISO 730 standards. Steering cylinders are mounted at the same axial and vertical height as the ball head coupling on the towing vehicle. Spacing 250 mm (+/- 5mm)

Adaptable – the Fliegl movable axle

mechanically

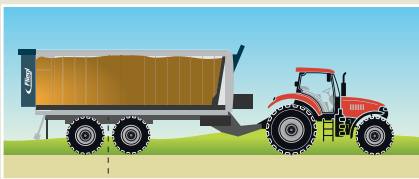

Optimal adaptation of drawbar load by mechanical axle shift (standard) or stepless hydraulic adjustment (as option)
Drawbar load adaptation possible also when mounting an attachment (e.g. a spreading unit)

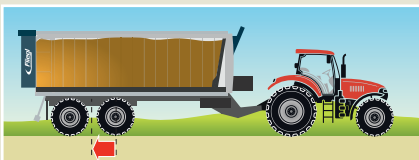

Axles shifted backward for use in the field
Higher drawbar load = more traction in the tractor

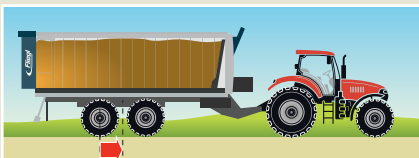

Axles shifted forward for use on the road
Lower drawbar load = greater ride comfort and less wear

hydraulic (optional)



Hydraulic axle adjustment

ASW equipment



Mechanical side wall folding

FWS ISOBUS weighing system

FWS ISOBUS weighs directly in the field, even on sloping ground, extremely accurately, quickly, and without recalibration.



Bedien-Terminal CCI-50

- 5.6" colour display
 - Membrane keypad
 - Touchscreen
- Interfaces: CAN1-In M12 8-pin connector, CAN1-Out M12 8-pin socket, SIGNAL/RS232 M12 12-pin socket, VIDEO M12 8-pin socket, LIN M8 4-pin socket, USB 2.0



Full LED rear lights with dynamic indicator made of impact resistant material.



Protectpackage



Mud guards and rear covers made of robust plastic parts guarantee clean surfaces and reduced risk of injury.



Rubber infill strips to prevent the lodging of dirt and debris.

Germany 40 km/h version with fixed underide guard



Large-area back wall with grain slider as standard



New push-off wall „Insight“ made of shatter resistant material



Frontgrating hydraulic



Fahrwerkstechnik
siehe Seite 25

Grating extension: adjustable mechanically in the standard version, hydraulically adjustable as option.

Ladder

Hydraulic drawbar suspension starting from ASW256 GIGANT - Hitch height continuously adjustable.



Drop support leg



Hydraulic supporting leg



Piton-Fix with swiveling eye



Ball-type coupling



Swivel Pitonfix



Piton-Fix



DIN pulling eye

Technical data ASW

ASW tandem | tridem

		ASW 110 single-axle	ASW 110	ASW 140
Total permitted weight	kg	10.500	11.000	14.000
Number of axles		1	2	2
Tongue load	kg	2.500	2.000	2.000
Net weight	approx. kg	3.750	4.200	4.700
Body length incl. back wall	mm	5.100	5.100	5.600
Body width	mm	2.380	2.380	2.380
Body side height	mm	1.500	1.500	1.500
Platform height with standard tyres	approx. mm	1.250	1.100	1.250
Track width*	mm	1.850 - 2.000	1.850 - 2.000	2.000
Fill volume without compression	approx. m ³	20	20	22
Fill volume with compression	approx. m ³	30	30	33
Required oil quantity	litre	12	12	13

		ASW 381 Gigant/GreenTec
Total permitted weight	kg	29.000 - 31.000
Number of axles		3
Tongue load	kg	2.000-4.000
Net weight	approx. kg	7.780/6.300
Body length incl. back wall	mm	8.100
Body width	mm	2.380
Body side height	mm	2.000
Platform height with standard tyres	approx. mm	1.400
Track width*	mm	2.050 - 2.150
Fill volume without compression	approx. m ³	40
Fill volume with compression with grass silage	approx. m ³	64
Required oil quantity	litre	28

		ASW 271 Taurus Fox
Total permitted weight	kg	21.000 / 22.000
Number of axles		2
Tongue load	kg	3.000 / 4.000
Net weight	approx. kg	8.300
Body length incl. back wall	mm	7.100
Body width	mm	2.380
Body side height	mm	2000/2.300
Axle type		410 x 120 BPW
Fill volume without compression	approx. m ³	35
Required oil quantity,	litre	21

ASW 160	ASW 256	ASW 261	ASW 271	ASW 281 Gigant/Green Tec
16.000	20.000 - 21.000	20.000 - 23.000	20.000 - 24.000	20.000 - 24.000
2	2	2	2	2
2.000	2.000-3.000	2.000-34000	2.000-4.000	2.000-4.000
4.900	5.500	6.200	6.800	7.500/6.100
5.600	5.600	6.100	7.100	8.100
2.380	2.380	2.380	2.380	2.380
1.500	1.500	2.000	2.000	2.000
1.250	1.400	1.400	1.400	1.450
2.000	2.050 - 2.150	2.050 - 2.150	2.050 - 2.150	2.050 - 2.150
22	22	30	35	40
33	33	48	56	64
13	16	17	21	28

ASW 391 Gigant/GreenTec	ASW 3101
29.000 - 34.000	29.000 - 34.000
3	3
2.000-4.000	2.000-4.000
8.720/7.170	9.450
9.100	10.100
2.380	2.380
2.000	2.000
1.400	1.400
2.050 - 2.150	2.050 - 2.150
45	50
72	80
30	32

ASW 281 Taurus Fox	ASW 381 Taurus Fox	ASW 391 Taurus Fox	ASW 3101 Taurus Fox
23.000 / 24.000	30.000/31.000	30.000/31.000	33.000/34.000
2	3	3	3
3.000 / 4.000	3.000/4.000	4.000	2.000-4.000
8.900	9.900	10.900	11.500
8.100	8.100	9.100	10.100
2.380	2.380	2.380	2.380
2000/2.300	2000/2.300	2000/2.300	2000/2.300
410 x 180 BPW	410 x 120 BPW	410 x 180 BPW	410 x 180 BPW
45	45	50	55
28	28	30	32

Technical data ASS

		ASS 2108 AgroTruck Gigant/Green Tec	ASS 298 AgroTruck Gigant/Green Tec
Total permitted weight	kg	35.000	35.000
Number of axles		2	2
Assumed fifth wheel load	kg	15.000	15.000
Coupling height +/-50 mm	mm	1.400	1.400
Net weight	approx. kg	9.900/ 8.900	8.900/ 7.900
Body length incl. back wall	mm	10.800	9.800
Body width	mm	2.380	2.380
Body side height	mm	2.000/2.300	2.000/2.300
Platform height with standard tyres	approx.mm	1.550	1.550
Track width*	mm	2.050	2.050
Fill volume without compression	approx. m ³	52 - 61	48 - 55
Required oil quantity	Liter	38	35

		ASS 288 Gigant/Green Tec	ASS 298 Gigant/Green Tec	ASS 2108 Gigant/Green Tec
Total permitted weight	kg			
Number of axles		2	2	2
Assumed fifth wheel load	kg	13.000 - 15.000	13.000 - 15.000	13.000 - 15.000
Net weight	approx. kg	7.700/ 6.700	7.900/ 6.900	7.300
Body length incl. back wall	mm	8.800	9.800	10.800
Body width	mm	2.380	2.380	2.380
Body side height	mm	2.000	2.000	2.000
Platform height with standard tyres	mm	1.400	1.400	1.400
Track width*	mm	2.050	2.050	2.050
Fill volume without compression	approx.	43	48	51
Required oil quantity	Liter	30	32	35



ASS 388
Gigant/Green Tec

ASS 398
Gigant/Green Tec

ASS 3108
Gigant/Green Tec

ASS 3118
Gigant

ASS 3125

ASS 388 Gigant/Green Tec	ASS 398 Gigant/Green Tec	ASS 3108 Gigant/Green Tec	ASS 3118 Gigant	ASS 3125
3	3	3	3	3
11.000 - 13.000	11.000 - 13.000	11.000 - 13.000	11.000 - 13.000	11.000 - 13.000
7.800/6.800	8.400/7.400	7.900	8.500	11.200
8.800	9.800	10.800	11.800	12.500
2.380	2.380	2.380	2.380	2.380
2.000	2.000	2.000	2.000	2.000
1.400	1.400	1.400	1.400	1.400
2.050	2.050	2.050	2.050	2.050
43	48	51	55	60
30	32	35	42	50

*abhängig von der Bereifung
**Volumen bei Schüttgut mit Schüttkegel





SPREADING SYSTEMS



Spreaders for ASW

“GIGANT” PUSH-OFF TRAILER WITH POWERFUL SPREADING GEAR

- Simple retrofit to all Fliegl push-off trailers
- You can convert your push-off trailer to a professional manure spreader within 20 minutes
- Universal application with any type of material, e.g. cattle or poultry manure, bulk and/or pourable materials such as sewage sludge, compost or lime
- Fine or wide-area spreading selectable
- Spreading gear with vertical rollers with enormous throughput capability - also optimal for silage spreading on flat silos



SPREADER “PROFI” DLG TESTED



Wide-spreading back wall



Sliding gate



Milling drums with throwing vanes

The spreading gear is driven mechanically by a PTO through-drive shaft

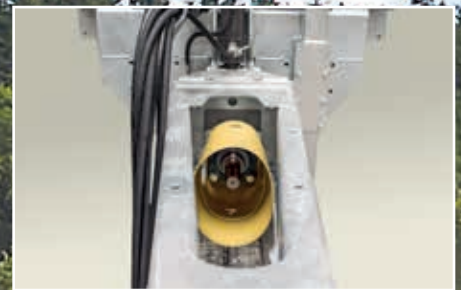

The milling drums break up the spreading material for uniform results.



Push-off speed is adapted automatically by the automatic feed control



With a stacker truck, all spreading units can be installed easily within about 20 minutes.

»Profi V2« and »Profi V2n«



FLIEGL ASW 271
✓ Verteilqualität
Stallmist
DLG-Prüfbericht 6293



Profi V2



Wide-spreading back wall



Sliding gate



Milling drums with slingers



The sliding gate is fully galvanised as standard. The spreading unit bearings can be accessed through a central lubrication bar for easy maintenance.



Spreader Profi V2 with slinger:

- Smooth startup
- Impervious to foreign objects
- Gentle on the gears, with low maintenance



ASW 271 WITH PROFI V2 STABLE MANURE 30 T/HA WITH REAR FLAP OPEN

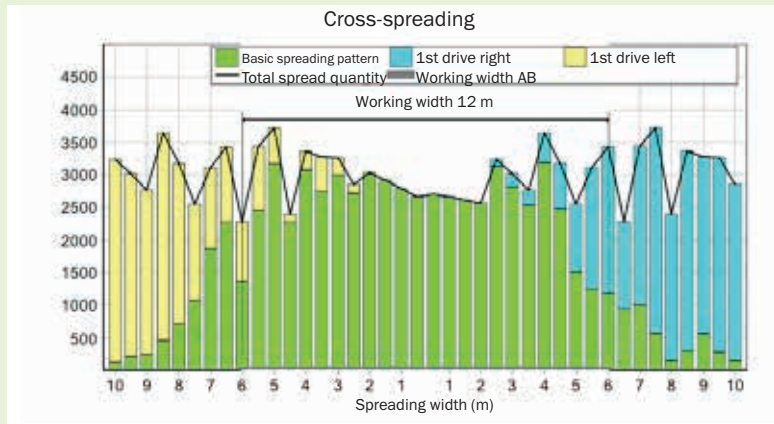

Travel speed: 5,5 km/h | coefficient of variation (VK): 13,2% | ++

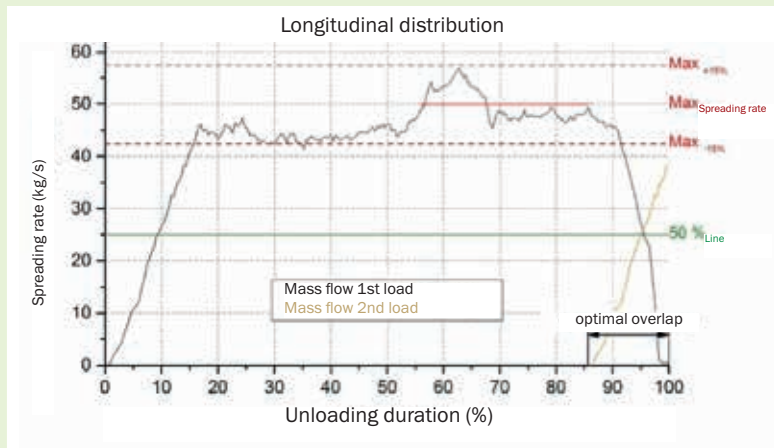

Coefficient of variation (VK): 9,79% | ++

DLG evaluation scale	VK% > 20 to 25	=	0
	VK% > 15 to ≤ 20	=	+
	VK% ≤ 15	=	++



Spreader "Profi V2n"
For push-off trailers with 1500mm body height



Spreader "Profi V2" with closed wide-spreading back wall

Perfect spreading pattern

WITH FLIEGL VARIOSENS SPREADING GEAR CONTROL
FOR SPREADER "PROFI V2" AND "PROFI V2N"





The ISOBUS Multi-Control is a multi-machine control system. It allows parallel operation of a FLIEGL VARIO SENS and a FLIEGL TRAILER CONTROL, for example. So the Multi-Control simplifies the work of the operator and also increases the efficiency of the application itself.

One operation step by step - automatically:

- 1 PTO speed is checked and controlled
- 2 Optional opening of rear flap, e.g. for solid manure
- 3 Sliding gate is opened
- 4 Sliding wall is pushed out at maximum speed
- 5 Sliding wall is controlled according to torque
- 6 Two emptying strokes to completely remove remaining material
- 7 Sliding wall is retracted at maximum speed
- 8 Rear flap is closed
- 9 Sliding gate is closed

CONTROL AND FEED SYSTEMS



Electric potentiometer with adjustable feed rate on control panel



Mechanical potentiometer with adjustable feed rate at the spreading unit



Automatic torque control with "VARIO-SENS" feed control

ADS push-off manure spreader

Solid manure spreading with patented push-off technology

Ideal: spreading pattern adjustable by hydr. drawbar tilt cylinder



Hydraulic drawbar suspension,
best ride comfort



Minimum wear with hydr. pushing system
- no scraper floor.



Hydraulic sliding gate

Robust spreading unit with working width about 12 m



High stability - low centre of gravity

With proven push-off technology

No sensitive wear parts compared with a scraper floor



Protective grating as standard



Slinger



ADS 200 with 19m³ volume

ADS 120 with spreading unit



FLIEGL ADS 120
✓ Verteilqualität
Stallmist
DLG-Prüfbericht 6292



With the proven Fliegl push-off technology, the material is fed evenly to the spreading unit. When the spreading is over, the loading area is virtually clear and the underfloor remains clean, unlike with conventional scraper floors.



ADS 120 WITH PROFI V2 SPREADING UNIT STABLE MANURE 10 T/HA WITH REAR FLAP OPEN

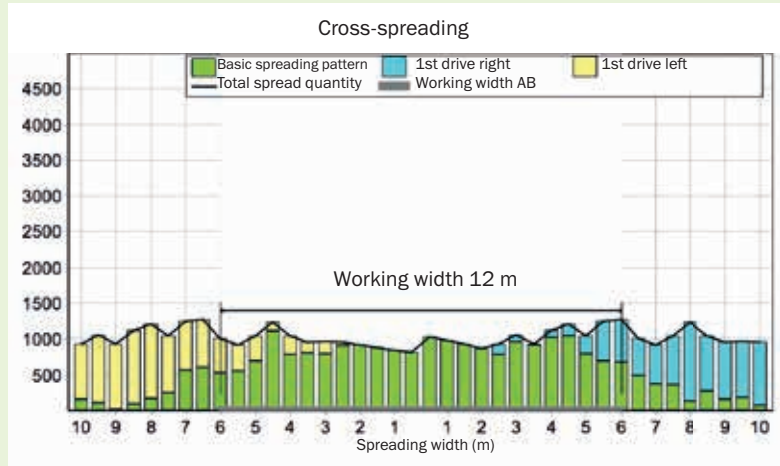

Travel speed: 7.5 km/h | coefficient of variation (VK): 12.7% | ++

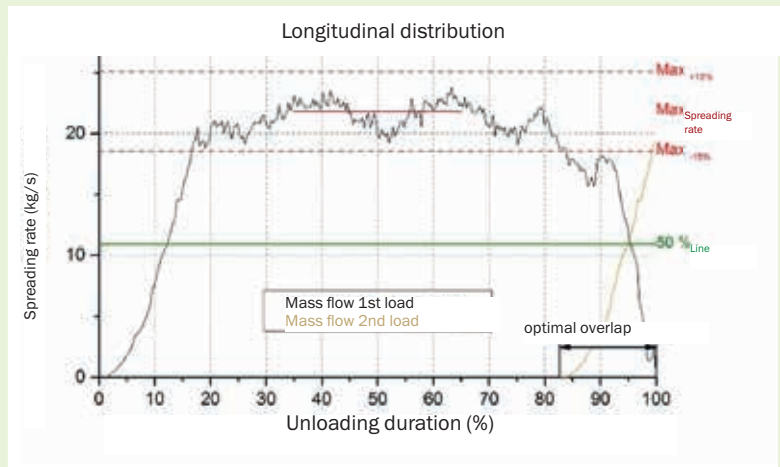

Coefficient of variation (VK): 8,03% | ++

DLG evaluation scale	VK% > 20 to 25	=	0
	VK% > 15 to ≤ 20	=	+
	VK% ≤ 15	=	++



Spreading unit Profii V2 with slinger:

- Impervious to foreign objects
- Gentle on the gears, with low maintenance



The sliding gate is fully galvanised as standard. The spreading unit bearings can be accessed through a central lubrication bar for easy maintenance.

Technical data ADS

		ADS 60	ADS 80
Total permitted weight	kg	6.000	8.000
Drawbar		Top hitch	Top hitch
Net weight	kg	3.900	3.900
Dimensions L x W x H	approx. mm	3.500 x 1.300 / 2.100 x 900	4.500 x 1.300 / 2.100 x 1.350
Volume	approx. m ³	6	9
Standard tyres		15/70-18 16 PR	385/65/22,5 RE

		ADS 160	ADS 160 Tandem
Total permitted weight	kg	14.000	16.000
Drawbar		Bottom hitch	Bottom hitch
Net weight	kg	7.300	7.300
Dimensions L x W x H	approx. mm	5.500 x 1.300 / 2.100 x 1.600	5.500 x 1.300 / 2.100 x 1.350
Volume	approx. m ³	18	14
Standard tyres		750/60 R 30.5	560/60 R 22.5



Optional: spreading roller protection and sliding gate for ADS 60



ADS 60 with 4 vertical rollers.



Optional:
40km/h version with mudguards with ADS 80 / ADS100 / ADS120



ADS 100

ADS 120

10.000	12.000
Bottom hitch	Bottom hitch
4.200	5.300
4.500 x 1.300 / 2.100 x 1.300	5.000 x 1.300 / 2.100 x 1.600
9	14
23.1/26	28 L 26

ADS 200 Tandem

20.000
Bottom hitch
8.200
5.500 x 1.300 / 2.100 x 1.600
19
560/60 R 22,5



Mechanical feed control through mechanical potentiometer



Optional: feed control by electric potentiometer



As an option, the ADS can be retrofitted with an 800mm large-area back wall for use as a transport trailer

Chain spreader »KDS«



Spreading roller guard

Two vertical rollers

- Capacity of 12 to 17 m³
- Single-axle or tandem
- Conical shape ensures deep design and low centre of gravity
- Low loading height
- Different control options
- Spreading width depending on spreader:
from 11 m (Junior), 14 m (Junior XL) to 24 m (MuckControl)



Hydraulically sprung drawbar for bottom attachment.

Spreading technology

KDS »junior« Universal spreader

Comprises two vertical rollers with a usable height of 1800 mm and passage width of 1500 mm. The spreading width is approx. 11 m.
Roller diameter: 755 mm



KDS »junior« Universal spreader XL

Comprises two vertical rollers with a usable height of 1800 mm and passage width of 2000 mm. The spreading width is approx. 14 m.
Roller diameter: 1045 mm



KDS »muck control«
varioSPLASH

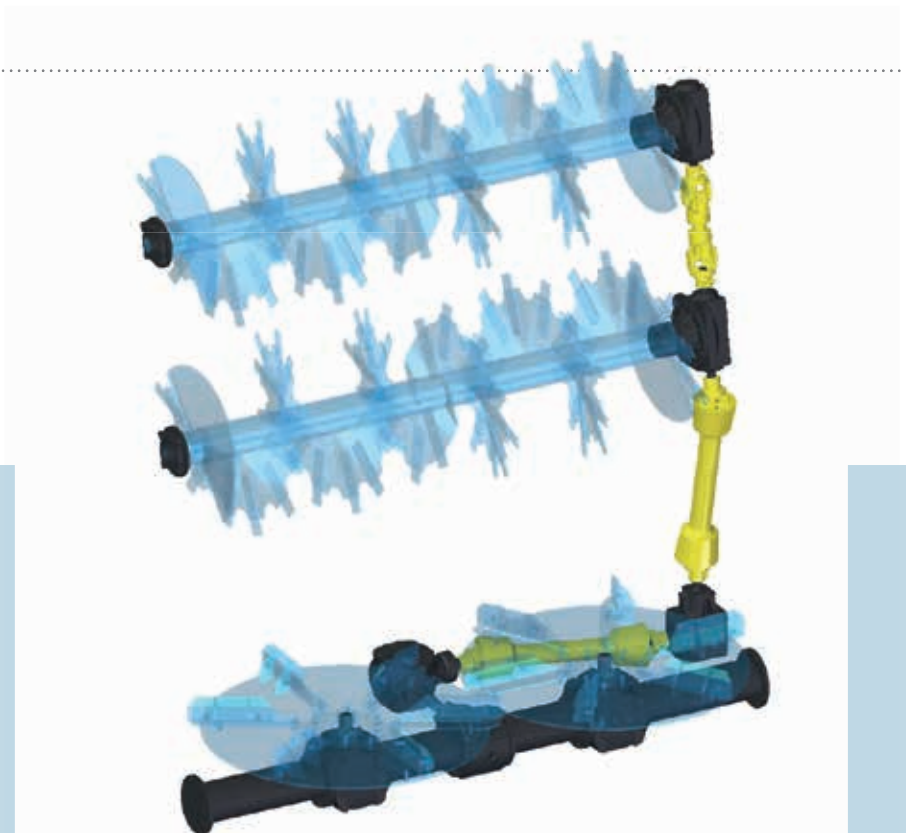

Drive train of the horizontal rollers. Overload protection via ratchet clutch in drive shaft to tractor.



The **varioSPLASH disc spreader** features two large spreading discs, each measuring 1100 mm in diameter and equipped with 6 spreader vanes adjustable perpendicularly to the spreading angle. They feature replaceable plates made from HB 400 steel and safety bolts for individual sensitivity adjustment. On tandem and tridem models, the angle of the spreading table features mechanical and optional hydraulic adjustment.



Spreader vane adjustment



Spreading widths of up to 32 m are possible with the varioSPLASH wide disc spreader.



Chain spreader »muck control«

SPREADING MATERIAL

Parameters for distribution quality of stable manure, compost, chicken dung and digestate

	Stallmist		Kompost		Hühnerkot		Gärrest	
	18	18	10	14	12	22	15	20
Working width [m]	18	18	10	14	12	22	15	20
Target discharge rate [t/ha]	18	18	10	14	12	22	15	20
Travel speed [km/h]	7,1	3,7	10,3	5,6	12,1	12,1	5,6	3,2
Transverse distribution								
Coefficient of variation (CV) [%]*	14,5 (+)	14,7 (*)	13,9 (+)	14,4 (+)	8,9 (++)	19,3 (o)	7,9 (++)	14,7 (+)
Longitudinal distribution								
Coefficient of variation (CV) [%]**	11,9 (+)	16,7 (o)	8,3 (++)	10,8 (+)	8,4 (++)	8,4 (++)	13,3 (+)	14,1 (+)
Dilation within tolerance zone [%]***	75,9 (++)	62,5 (+)	92,4 (++)	87,4 (++)	91,2 (++)	91,2 (++)	83,2 (++)	69,7 (+)



The two mixing rollers each have a diameter of 770 mm, are centrally wound and fitted with bolted tines made from wear-resistant steel (HB 400).

The hydraulic tailgate provides convenient access for maintenance purposes and features spindles to enable variable material transfer to the distributing plates.

The material is spread via 2 distributing plates, each equipped with 6 adjustable spreader vanes made from HB 400 steel.

Optional: electronic speed monitoring

Monitors the speed of the mixing rollers and automatically deactivates the material chain conveyor when necessary to protect the system against damage due to foreign objects.



Heavy-duty side-mounted gearbox with 60 mm shaft ensures steady and uniform material feed

Hydraulic tailgate



KDS 270 »muck control« | tandem

- 25 m³ load wall
- Side walls and floor made from fine-grain steel
- Chassis made from robust hollow section frame
- Hydraulically sprung drawbar
- Swivelling traction bar



Hydraulically sprung drawbar for bottom attachment. The coupling height can be easily adjusted.



Supporting stand
Adjustable, centrally rearward-folding for maximum stability



KDS 260: body made from fine-grain steel



Ladder



Folding body attachment



Stone guard

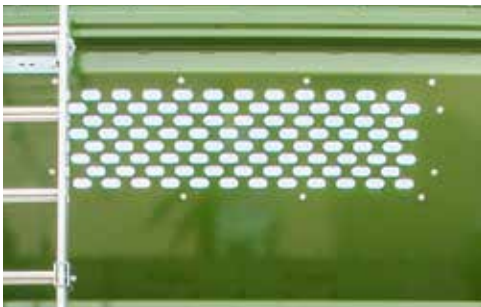

Front inspection grille



The sliding gate opening scale on the front shows the opening position of the sliding gate.



Easily accessible chain wheels which can be lubricated through the shaft on either side



Central lubrication point



Mechanical chain tensioning



Hydraulic chain tensioning

Equipment

Not all equipment options shown are available for all models.

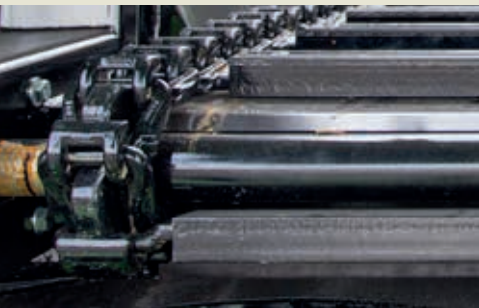

Forged chain links with 20 mm diameter and a breaking load of 50 t along with solid conveyor strips that are closed at the top and spaced at 300 mm intervals to ensure even and reliable transport of even the heaviest of materials.



On KDS tandem and tridem:
chassis guard (manure protection)



„Dynamic“ full-LED rear light with dynamic indicator made from impact-resistant material



Extra heavy-duty gearbox

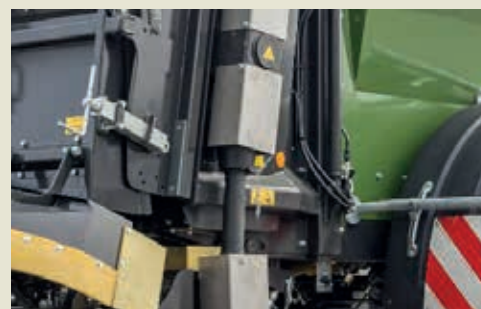

Milling drum drive above drive shaft



Edge spreading device
Available as single attachment for left or right, or for both sides.



Mechanical potentiometer with feed rate adjustment at front of spreader body



Electrical potentiometer with feed rate adjustment on control panel

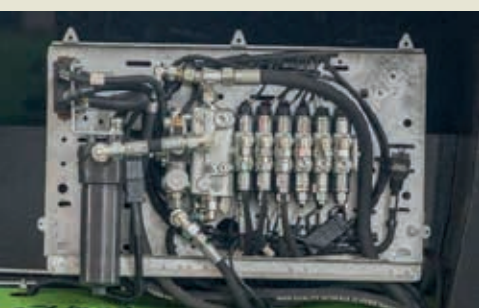

Control block with control panel for convenient operation

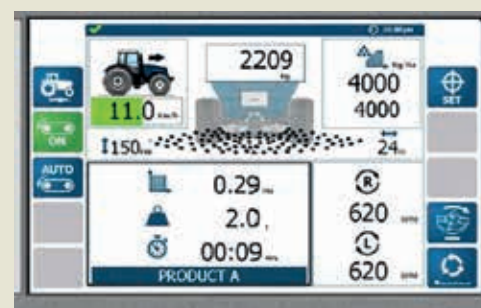

SpreaderControl

- For controlling the discharge rate
- Speed control via GPS system
- Accurate spreading pattern thanks to automatic feed control based on speed and possible spreading width

Technical data

Single-axle/tandem/tridem chain manure spreader



		KDS 120	KDS 140	KDS 165
Perm. total weight	kg	13.000	13.000	14.000
Number of axles		1	1	1
Drawbar load	kg	3.000	3.000	4.000
Net weight	approx. kg	4.900	5.300	7.800
Body length	mm	4.500	5.500	6.500
Body width	mm	1.350 – 1.800	1.350 – 1.800	1.350 – 1.800
Loading sill height	mm	2580	2580	2580
Lateral body height	mm	1.450	1.450	1.450
Volume	approx. m ³	10	12	15
Volume, heaped	approx. m ³	12	14	17



KDS 260 »muck control«



	KDS 265	KDS 260 Muck	KDS 270 Muck	KDS 390 Muck
	20.000	20.000	20.000	29.000
	2	2	2	3
	2.000	2.000	2.000	2.000
	7.800	8.400	9.500	11.500
	6.500	6.000	7.000	9.000
	1.350 – 1.800	2.150	2.150	2.150
	1.450	1.400	1.400	1.400
	15	20	23	30
	17	22	25	32

Available spreaders/type

	Spreader Junior	Spreader Junior XL	Wide spreader Vario Splash
KDS 120	✓	⊙	⊙
KDS 140	✓	⊙	⊙
KDS 165	✓	⊙	⊙
KDS 265	✓	⊙	
KDS 260 Muck			✓
KDS 270 Muck			✓
KDS390 Muck			✓

Standard equipment
 Optional





THREE-WAY TIPPER AND DUMPER



One-axle three-way tipper

from 2.6 to 8 t total weight

Advantages

- Robust hollow section frame
- Low centre of gravity
- Low net weight
- Nevertheless extremely robust and torsion-resistant
- Galvanised frame
- High stability
- Compact design
- High manoeuvrability
- Large tilt angle
- Available with side wall extensions



All tipper frames are HOT-DIP GALVANISED as standard



EDK 25 with leaf protection top piece





...suitable for any tractor size!

Equipment for EDK

Frame:
weight optimised frame for maximum payload

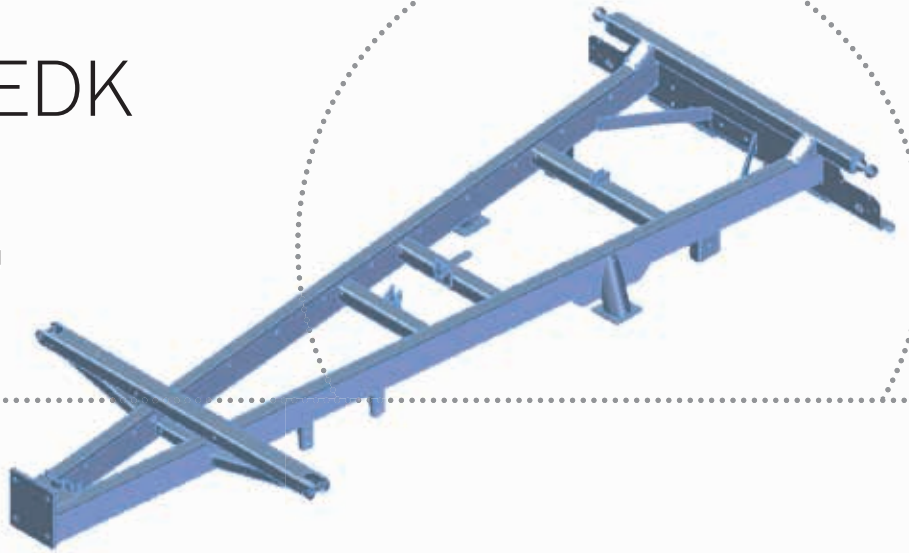

Bridge:
plug-in corner stanchions,
all-round rubber seal in special rubber profile
(starting from EDK 60)

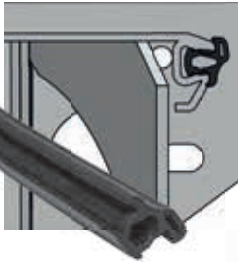

Basic tailgate:
steel tailgates, sandblasted,
primed and powder-coated



2 five-chamber lights with
shock-resistant glass

Grain outlet starting from
EDK 40

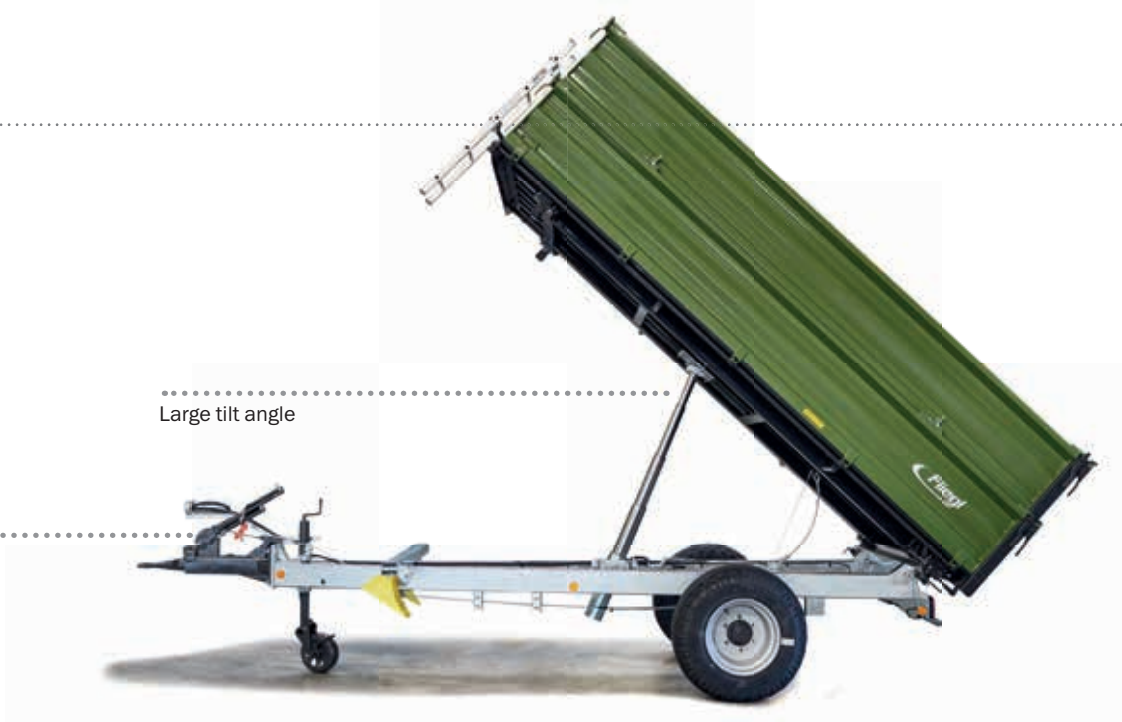

Large tilt angle



Optional:
body 500 mm with ladder

Large-size axle with wide track
for best stability

Hollow section
frame, galvanised

Heavy-duty support wheel,
folding

Braking systems:
not braked
Parking brake
Overrun brake
Hydraulic brake
Compressed air brake

Two-axle three-way tipper

with total weight from 6 to 18 t



Top chassis!

- Bridge made of high-grade steel - sandblasted, dipcoat primed with two-component coating
- Galvanised, continuously formed frame, made with high-quality fine-grained steel (welded structure)
- Heavy-duty suspension
- Heavy-duty truck type slewing ring
- Galvanised frame optional





DK 180-88 XL

- With centre stanchions
- Parabolic suspension, lubrication-free
- Bridge 5,250 x 2,320 x 800 mm
- Body 600 mm or 800 mm



DK 180-88 Maxum:

- Parabolic suspension, lubrication-free
- Bridge 5,050 x 2,420 x 800 mm
- Body 600 mm or 800 mm



Roll-out tarpaulin with optional platform

Three-axle DDK three-way tipper with total weight 24 t

- Bridge length: 6.20 m / 7.20 m or 7.80 m
- Accessories: Platform
- Accessories: Tarp frame with roll-out PVC tarp



Advantages

- 3-axle three-way tipper, 24 t total weight with centre stanchion
- Bridge with high-grade steel – sandblasted, dipcoat primed with two-component coating
- Continuous frame (welded structure)
- Heavy-duty suspension, parabolic suspension, lubrication-free
- Heavy-duty, truck type slewing ring
- ALB



DDK 310 three-axle three-way tipper

The grain master! Combines the benefits of a three-axle tipper with the payload and traction of a tridem tipper.

Details

- Perm. total weight 31,000 kg
- Bridge: 8200 mm x 2320 mm
- Highly manoeuvrable thanks to three-axle chassis
- Roll-off tarpaulin with optional platform possible
- Tyres: 560/45 R 22.5 possible
- 420 mm x 250 mm grain hatch possible
- Swivelling draw gear for top or bottom attachment
- Lateral potato/beet slide possible



Central locking as STANDARD:
left, right and rear



High tipping angle

DK equipment

Frame:
weight-optimised frame from the utility vehicle division
for perfect ground adaptation

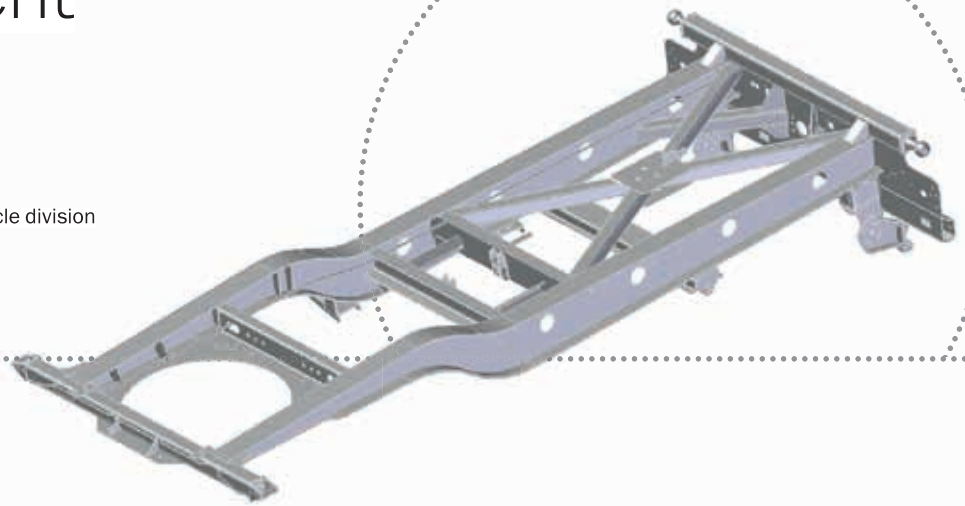

Bridge:
plug-in corner stanchions, all-steel floor, all-round
rubber seal in special profile, bridge frame made
with high-grade steel sections, torsion-resistant
and stable

Basic tailgate:
central locking rear, right and left, steel tailgates sand-
blasted, primed and powder-coated

2 five-chamber lights with
shock-resistant glass
Optional: LED

Optional: Structure



Optional:
trailer coupling rear, 8 t or
automatic up to 18 t

Rear grain slider



Large tilt angle

Optional:
tarp frame with PVC tarp



Optional:
Body with ladder

Optional:
platform

Optional:
tailgate tension spring

Series:
V-drawbar

Optional:
Y-drawbar

Frame as welded structure

Tandem three-way tipper from 8 to 20 t total weight

- Tandem tipper with hollow section frame proven thousands of times over
- Tapered bridge, length starting from 4,500 mm
- Tilt angle (up to 55° possible) for best run-out of any kind of bulk goods
- Robust: tailgates integrated in the automatic and the hydraulic back wall allow grain transport even with the silage body
- Grain slider as standard
- Front viewing grille on silage body as standard
- Extra-large axle gauge ensures outstanding stability on any terrain
- Particularly low platform height
- Side walls can be opened for loading



TDK 160 with hydr. gravel flap 500 mm
Bridge: 5000 x 2320 x 2220 mm

40 km/h version with underride guard
and mudguards



Hydraulic back wall with automatic locking

- + With the new locking system developed by Fliegl, the back wall is first raised a bit vertically, then swivelled out.
- + The hydraulic back wall opens by about 90° to allow loading from the rear.

With tapered bridge for complete emptying!



TDK 160 with 1800 mm body
(3 x 600 mm tailgate)



Silage tipper with hydraulic back wall



Frame and TDK body

Fliegl tippers starting from the TDK 130 Series are fitted with a durable Titan tandem assembly which has been proven thousands of times over – for optimal ground compensation up to 30 cm.

Unique: The Fliegl wide-gauge chassis for greater stability!

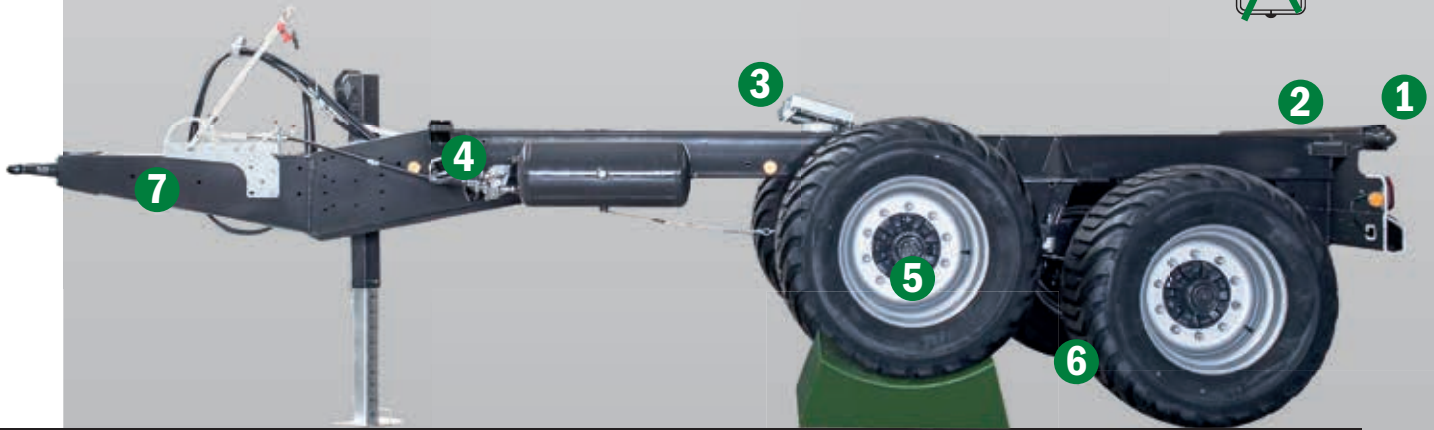
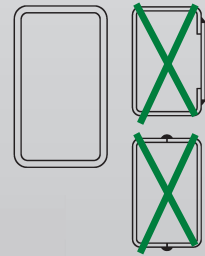

- 1** Large-size tilt ball bearing, extremely wide on the outside, for best stability.
- 2** Continuous, robust tipping cross bar, with extra-wide bearing at the rear.
- 3** Large-size tilt cylinder (gimbal mounting).
- 4** Extra-strong hollow section frame: (no welded U-profiles) ensures maximum stability (absolute torsion-resistance), so no warping is possible.
- 5** Heavy-duty axles with plenty of reserve.
- 6** Extra-large track width for unparalleled stability on challenging terrains.
- 7** Swivelling drawbar for top or bottom hitch.



Gigant tandem assembly - parabolic suspension



Titan tandem assembly for best ground adaptation, lubrication and maintenance free.

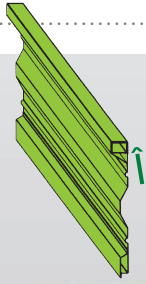

Perfection already at production!

- Steel tailgates - sandblasted, primed and powder-coated
- Basic tailgate starting from 4.5 m, extra reinforcement with socket pipes



Extremely robust body for the toughest jobs...

- 1 Heavy-duty corner stanchions.
- 2 Adjustable tailgate tightener (option).
- 3 Heavy-duty cross bridge for optimal overloading weight.
- 4 Additional hard rubber cushion.
- 5 Heavy-duty bridge frame for extreme torsion resistance.



Absolutely secure!

- Tilt ball bearing at rear
- Two ball sockets with polyamide inlay on tempered ball heads, noise-absorbing, maintenance-free, low-wear, and centred exactly.
- The pivot pins are made so that any crossover points are excluded.

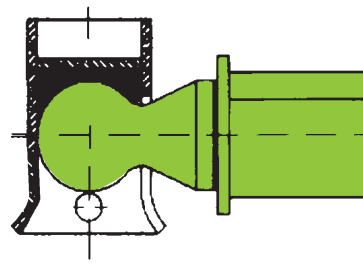

TDK equipment

Optional:
Hydraulic back wall
with integrated tailgates

- Bridge (tapered):
 - Plug-in corner stanchions, steel floor,
 - all-round rubber seal in special profile
- Basic tailgate:
 - Socket pipe, central locking rear, right and left, tight-
 - ening strap, steel tailgates sandblasted, primed and
 - powder-coated



2 five-chamber lights with
shock-resistant glass
Optional: LED

Grain outlet

Optional structural items available

Large tilt angle



Optional: grating front panel as standard in connection with hydr. back wall

Optional: body with ladder

DIN drawbar eye 40 mm

Traction bar without suspension, swivelling for top or bottom hitch

Profi frame galvanised

Available:
• Heavy-duty support wheel, folding
• Support leg with 2 speeds,
• Hydraulic support leg

Tandem chassis, "Titan" tandem vehicle assembly with parabolic suspension

Technical data Three-way tipper

EDK | DK | DDK

One-axle three-way tipper

		EDK 20	EDK 25	EDK 40
Total permitted weight:	kg	2.250	2.750	4.000
perm. drawbar load	approx. kg	250	250	1.000
Net weight	approx. kg	500	600	950
Bridge size inside L	approx. mm	2.000	2.500	3.000
Bridge size inside W	approx. mm	1.200	1.500	1.600
Tailgate height	approx. mm	400	400	400
Bridge tapered				
Platform height approx. 1)	mm	720	800	850
Track width	mm	1.000	1.250	1.350
Tyres 2)		205 R 14	10/75/15	10/75/15
Tilt cylinder stroke	mm	900	900	900
Required oil quantity	approx. ltr.	4	4	7
Rear central locking		optional	optional	Standard
Side central locking				optional

Two-axle three-way tipper

		DK 60	DK 80	DK 110-88	DK 140-88
Total permitted weight:	kg	6.000	8.000	11.000	14.000
Net weight	approx. kg	1.600	1.850	2.000	2.720
Bridge size inside L	approx. mm	4.000	4.500	4.500	4.500
Bridge size inside W	approx. mm	2.000	2.220	2.220	2.220
Tailgate height	approx. mm	500	500	500	500
Bridge tapered			Standard	Standard	Standard
Platform height approx. 1)	mm	1.050	1.200	1.250	1.300
Track width	mm	1.650	1.850	1.850	1.850
Tyres 2)		10/75/15	11,5/15	12,5/80/18	385/65/22 RE
Tilt cylinder stroke	mm	1.500	1.850	1.850	1.850
Required oil quantity	approx. ltr.	12	14	14	16,5
Rear central locking		Standard	Standard	Standard	Standard
Side central locking		Standard	Standard	Standard	Standard
Centre stanchions					

1) depending on version and in the loaded state

2) other tyres on request

Other special equipment on request

EDK 50	EDK 60	EDK 65	EDK 80 -4000	EDK 80 -4500
5.500	6.000	6.000	8.000	8.000
1.000	1.000	1.000	1.000	1.000
1.000	1.200	1.400	1.600	1.700
3.500	4.000	4.000	4.000	4.500
1.800	2.000	2.200	2.200	2.200
400	500	500	500	500
				Standard
880	980	1.050	1.180	1.180
1.450	1.650	1.850	1.850	1.850
11,5/15	11,5/15	13/75/16	385/65/22 RE	385/65/22 RE
1.200	1500	1.500	1.500	1.850
7	12	12	12	14
Standard	Standard	Standard	Standard	Standard
optional	Standard	Standard	Standard	Standard

Three-axle three-way tipper

DK 160	DK 140-88-5	DK 180-88	DK Max. 180-88	DDK 240-6,20	DDK 240-7,20	DDK 240-7,80
16.000	14.000	18.000	18.000	24.000	24.000	24.000
3.820	3.700	4.200	3.850	5.800	6.200	7.100
4.500	5.000	5.150	5.050	6.200	7.200	7.800
2.320	2.320	2.420	2.420	2.320	2.320	2.320
800	600	800	800	800	800	800
Standard	Standard					
1.300	1.300	1.350	1.350	1.400	1.400	1.400
1.850	1.850	1.950	1.950	1.950	1.950	1.950
385/65/22 RE	385/65/22 RE	385/65/22 RE	385/65/22,RE	385/65/22 RE	385/65/22 RE	385/65/22 RE
1.850	2.150	2.000	2.000	2.250	2.250	2.500
16,5	20	28	28	35	35	40
Standard	Standard	Standard	Standard	Standard	Standard	Serie
Standard	Standard	Standard	Standard	Standard	Standard	Serie
		Standard		Standard	Standard	Serie

Technical data TDK

Tandem three-way tipper

		TDK 80	TDK 80-88	TDK 110-88
Total permitted weight	kg	8.000	8.000	11.000
perm. drawbar load	approx. kg	1.000	1.000	2.000
Net weight	approx. kg	1.800	1.950	2.250
Bridge size inside L	approx. mm	4.000	4.500	4.500
Bridge size inside W	approx. mm	2.200	2.220	2.220
Tailgate height	approx. mm	500	500	500
Bridge tapered			Standard	Standard
Platform height approx. 1)	mm	1.150	1.150	1.180
Track width	mm	1.850	1.850	1.850
Tyres 2)		11,5/15	11,5/15	13/75/16
Tilt cylinder stroke	mm	1500	1.850	1.850
Required oil quantity	approx. ltr.	12	14	14
Rear central locking		Standard	Standard	Standard
Side central locking		Standard	Standard	Standard

Tandem three-way tipper with hydr. gravel flap

		TDK 110 S	TDK 140 S	TDK 160 S
Total permitted weight	kg	11.000	14.000	16.000
perm. drawbar load	ca. kg	2.000	2.000	2.000
Net weight	ca. kg	2.550	3.600	3.800
Bridge size inside L	ca. mm	4.500	4.500	5.000
Bridge size inside W	ca. mm	2.320	2.320	2.320
Tailgate height	ca. mm	500	500	600
Bridge tapered		Serie	Serie	Serie
Platform height approx. 1)	mm	1.180	1.300	1.300
Track width	mm	1.850	1.850	1.850
Tyres 2)		19/45-17 14 PR	355/60 R18	385/65/22,5 RE
Tilt cylinder stroke	mm	1.850	1.850	2.150
Required oil quantity	ca. ltr.	14	16,5	20
Rear central locking		Serie	Serie	Serie
Side central locking		Serie	Serie	Serie

1) depending on version and in the loaded state

2) other tyres on request

Other special equipment on request



TDK 140-88	TDK 160	TDK 200	TDK 255
14.000	16.000	20.000-21.000	20.000-23.000
2.000	2.000	2.000	2.000
3.300	3.500	4.400	4.600
4.500	5.000	5.000	5.500
2.220	2.320	2.320	2.320
500	600	600	800
Standard	Standard	Standard	Standard
1.300	1.300	1.350	1.350
1.850	1.850	2.050	2.050
385/65/22,5 RE	385/65/22,5 RE	385/65/22,5 RE	385/65/22,5 RE
1.850	2.150	2.150	2.150
16,5	20	28	28
Standard	Standard	Standard	Standard
Standard	Standard	Standard	Standard



TMK dumper

Fliegl dumpers are distinguished by their greater diversity, innovative details with know-how from the Fliegl utility vehicle production, and customised versions for special applications.

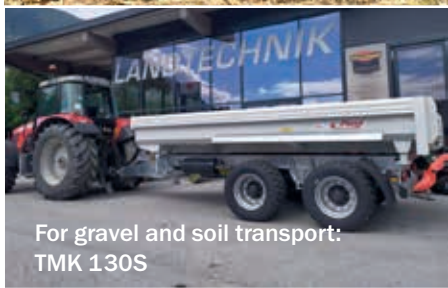

For gravel and soil transport:
TMK 130S



Mechanically folding protective grating



standard starting from TMK 256:
hydraulic drawbar suspension and drop
support leg, mechanical



Galvanised body, folding



TMK Potato

- Body height 1250 mm
- Jumbo chassis
- Body length 6.60 m
- Large grille with removable inspection panel



With tapered body for complete emptying



- Pull-out ladder
- Series: front inspection window

Other advantages:

- Low net weight for more loading capacity
- Unique Fliegl wide-gauge chassis for best stability
- Titan tandem assembly proven thousands of times over, for optimal ground compensation up to 30 cm
- Various assemblies available
- Heavy-duty, powerful underride guard with protected lighting

Dumper TMK Profi

With round front wall and volume rear flap starting from TMK 264
More volume thanks to compact shape and short frame design



The TMK 373 Profi with body length 7.30 m



Tandem TMK 269 Profi with body length 6.90 m and tilt angle about 55°

TMK 266 S heavy-duty dumper

One tipper – many possibilities! Combines the stability of a heavy-duty half-pipe with the volume of a high-capacity tipper.



Details

- Half-pipe body made from high-strength steel S 700 MC
- Body size: 6500 mm x 2220 mm x 1650 mm
- Sideways folding body attachment, 500 mm
- Tyre size: 750/45 R 22.5 possible
- Low centre of gravity thanks to Jumbo assembly
- Hydraulically sprung draw gear
- Swivelling draw gear for top or bottom attachment

TMK frame and body

+ Unique:

The Fliegl wide-gauge chassis for greater stability!

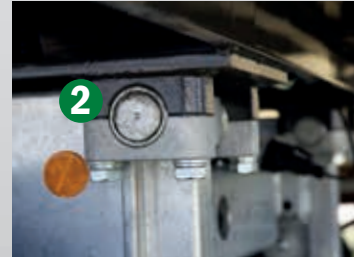
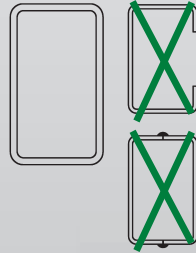

- 1** Large size tilt ball bearing up to body size 5.15 m for optimum stability.
- 2** All Bull bodies and dumpers starting from TMK 256 have a heavy-duty tilt bearing mounted directly on the frame
- 3** Continuous, robust tipping crossbar, extra-wide bearing at the rear.
- 4** Large-size tilt cylinder (gimbal mounting).
- 5** Specially strong hollow section frame: (no U-sections welded together) ensure maximum stability (absolute torsion resistance), so warping of the frame is not possible.
- 6** Heavy-duty axles with plenty of reserve.
- 7** Extra-large track width for unparalleled stability on challenging terrains.
- 8** Swivelling drawbar for top or bottom hitch.



Always variable – the Fliegl Profi frame!

- Standard starting from TMK 140
- Swivelling drawbar for top or bottom hitch
- Drawbar with suspension (standard starting from TMK 256 body length 5650 mm)



- 1 Heavy-duty cross bridge for optimal overloading weight
- 2 Heavy-duty bridge frame for extreme torsion resistance
- 3 Reinforcement sections edged and rounded from one piece
- 4 Side walls shaped from one piece
- 5 Large tilt angle



Gigant tandem assembly (TMK 200 starting from 5.65 m body length)



Tandem assembly "Gigant Plus"



Titan tandem assembly for best ground compensation.

TMK equipment

Optional:
body top piece

Body:
tapered, all steel

2 five-chamber lights
with shock-resistant glass
Optional: LED



Grain outlet

Large-sized tilt angle



55°

Hydraulic back wall

Series:
inspection window and ladder



DIN drawbar eye 40 mm

Available:
Heavy-duty support wheel, folding
Support leg with 2 speeds,
Hydraulic support leg

Profi frame galvanised
Swivelling drawbar for
top and bottom hitch

Technical data

One-axle/tandem/tridem dumper

One-axle dumper

		EMK 80	EMK 110
Total permitted weight:	kg	8.000	11.000
perm. drawbar load	kg	1.000	1.500
Net weight	kg approx.	2.600	2.690
Body inside length	mm approx.	4.650	4.650
Body inside width	mm approx.	2.320	2.320
Body inside height	mm approx.	1.300	1.300
Bridge tapered		yes	yes
Platform height approx.	mm	1.300	1.300
Track width	mm	1.850	2.050
Tyres		385/65-22,5 RE	385/65-22,5 RE
Tilt cylinder stroke	mm	1.850	1.850
Required oil quantity approx..	l	15	15
Hydraulic back wall		yes	yes

Tandem dumper

		TMK 200-5,15	TMK 256	TMK 264
Total permitted weight:	kg	20.000 – 21.000	20.000 – 23.000	20.000 – 24.000
perm. drawbar load	kg	2.000	2.000	2.000
Net weight	kg approx.	4.100	4.550	5.200
Body inside length	mm approx.	5.150	5.650	6.400
Body inside width	mm approx.	2.320	2.320	2.320
Body inside height	mm approx.	1.500	1.500	1.500
Bridge tapered		yes	yes	yes
Platform height approx.	mm	1.300	1.400	1.400
Track width	mm	2.050	2.050	2.050
Tyres		385/65-22,5 RE	385/65-22,5 RE	385/65-22,5 RE
Tilt cylinder stroke	mm	2.150	2.455	2.455
Required oil quantity approx..	l	28	28	32
Hydraulic back wall		yes	yes	yes

Heavy-duty dumper

		TMK 130 S	TMK 200 S	TMK 266 S PROFI	TMK 375 S PROFI
Total permitted weight:	kg	13.000	20.000	20.000	30.000
perm. drawbar load	kg	2.000	2.000	2.000	3.000
Net weight	kg approx.	3.400	4.500	5.700	8.400
Body inside length	mm approx.	4.500	5.000	6.500	7.500
Body inside width	mm approx.	2.300	2.300	2.220	2.220
Body inside height	mm approx.	500	900	1.650	1.650
Bridge tapered		no	no	no	no
Platform height approx.	mm	1.250	1.300	1.500	1.500
Track width	mm	1.850	2.050	2.050	2.050
Tyres		15/70-18 16 PR	385/65-22,5 RE	650/55 R 26.5	650/55 R 26.5
Tilt cylinder stroke	mm	1.850	2.150	2.950	3.400
Required oil quantity approx..	l	16,5	28	35	39
Hydraulic back wall		yes	yes	yes	yes

	TMK 80	TMK 110	TMK 140	TMK 160	TMK 190
	8.000	11.000	14.000	16.000	19.000
	1.000	2.000	2.000	2.000	2.000
	2.910	2.990	3.300	3.850	4.900
	4.650	4.650	4.650	5.150	5.950
	2.320	2.320	2.320	2.320	2.320
	1.300	1.300	1.300	1.500	1.500
	yes	yes	yes	yes	yes
	1.100	1.100	1.250	1.250	1.250
	1.850	1.850	2.000	2.000	2.000
	12,5/80 -18	12,5/80 -18	385/65-22,5 RE	385/65-22,5 RE	550/60-22,5 16 PR
	1.850	1.850	1.850	2.150	2.150
	15	15	16,5	20	20
	yes	yes	yes	yes	yes

Tridem dumper

	TMK 269	TMK 273	TMK 373	TMK 378
	20.000 – 24.000	21.000 – 24.000	29.000 – 33.000	29.000 – 33.000
	2.000	2.000	2.000	2.000
	5.600	5.800	6.200	6350
	6.900	7.300	7.300	7.800
	2.320	2.320	2.320	2.320
	1.500	1.500	1.500	1.500
	yes	yes	yes	yes
	1.400	1.400	1.400	1.400
	2.050	2.050	2.050	2.050
	385/65-22,5 RE	385/65-22,5 RE	385/65-22,5 RE	385/65-22,5 RE
	2.545	3.400	3.400	3.400
	37	39	39	39
	yes	yes	yes	yes





TRANSPORT TECHNOLOGY



HOOK LIFT SYSTEM



Hook lift system as tandem or tridem roll-off tipper

Extremely powerful, with universal and flexible application.

Available with different roll-off bodies

High tilt angle of up to 50 °



Tandem HKL18



1. Locking system
2. Hydraulic support at the axle
3. Remote control



Tridem HKL29

With just one hook lift chassis, a variety of containers, including original Fliegl push-off containers, and even large slurry tanks can be transported - saving time and costs. This vehicle is especially suitable for tasks where the container has to be stationary when filled.

HOOK LIFT SYSTEM



Reversible locking system for inside and outside locking

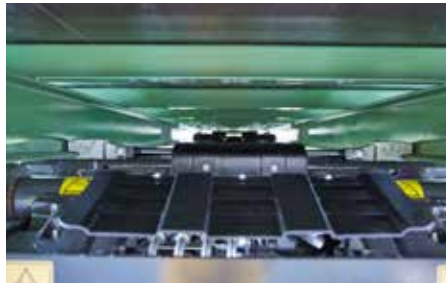

Optional: hydraulic support at the axle



Optional: air suspension with automatic lowering when tipping



Optional: extendible lighting carrier



Optional: extendible lighting carrier, brake connection and hydraulics for 2nd trailer



Automatic hook lock for tipping process



Tyres 560/60 R22.5



Swivelling drawbar for top and bottom hitch



Operation by remote control (optional)



Hydraulic drawbar suspension



Geschmiedeter, einfach auswechselbarer Aufnahmehaken



Large cast steel rollers (ø 310mm) with large centring bevel make it easier to raise the container.



On-board hydraulics 60 litre (optionally 90 l) driven by PTO shaft with hydraulic pump and oil container



Tandem assembly "Gigant Plus"



Air suspension



Gigant tandem assembly

		HKL 18	HKL 22	HKL29
Total permitted weight	kg	18.000	20.000	29.000
perm. drawbar load	kg	2.000	2.000 bis 4000	2.000 bis 4000
Net weight depending on version	kg approx.	4.900	5.840	6.900
Lifting force	kg	16.000		27.000
Container length	mm approx	4.500 – 5.500	4.500 – 7.000	4.500 – 7.000
Roller height with tyres 385/65-22,5 RE	mm	1.160	1.160	1.260
Tilt angle	degrees	54	54	54
Track width depending on tyres	mm	2050/2150	2050/2150	2050/2150
Tyres		385/65-22,5 RE	385/65-22,5 RE	385/65-22,5 RE
Required oil quantity approx.	l	35	35	eigene Bordhydraulik
Hydr. body locking	inside + outside	Serienausstattung	Serienausstattung	Serienausstattung

Platform trailer

tandem, two-axle and three-axle trailer with total weight from 8 t to 24 t.



Switch the loading side simply by releasing and fixing the safety bolt

Non-slip loading surface



DPW 210 Ultra with open load securing



DPW 210 Ultra with closed load securing. Opening is possible on the right or left.

		ZPW 80	ZPW 100	ZPW 140	ZPW 180
Total permitted weight	kg	8.000	10.000	14.000	18.000
Bridge length	mm	5.400 – 8.200	5.400 – 8.200	5.400 – 8.200	5.400 – 8.200
Bridge width	mm	2.480	2.480	2.480	2.480
Tyres		15/55-17	12,5/80-18	385/65-22,5 RE	385/65-22,5 RE

		ZPW 120 B	DPW 180B	ZPW 160 BL	DPW 210 BL Profi	DPW 210 BL Ultra
Total permitted weight	kg	12.000	18.000	16.000	21.000	21.000
Bridge length	mm	6.900	9.900	6.900	9.900	9.900
Bridge width	mm	2.480	2.480	2.480	2.480	2.480
Tyres		12,5/80-18	12,5/80-18	385/65-22,5 RE	385/65-22,5 RE	385/65-22,5 RE

		DPW 240	TPW 100	TPW 140	TPW 180
Total permitted weight	kg	14.000	10.000	14.000	18.000
Bridge length	mm	6.900 – 9.900	5.400 – 8.200	5.400 – 8.200	6.900 – 8.200
Bridge width	mm	2.480	2.480	2.480	2.480
Tyres		385/65-22,5 RE	235/75 R 17,5	385/65-22,5 RE	385/65-22,5 RE



Bale grid for type DPW 180 B as standard
Optional: rear extension (1200 mm)



Optional: bale grid, straight

Platform trailer TPA with drive-on ramps

from 12 t to 29 t



From TPA 200 on: Hydraulic tipping drawbar



Corner stanchions are plug-in type for easy drive-on



Drive-on ramps with wood covering, bridge floor made of 3.5 mm steel sheet, painted on the TPA 120



Drive-on ramps as standard with spring jack, and hydraulically operated as option



Bridge rear tapered to about 900 mm



Rear support with 2 drop legs



Practical: movable drive-on segments to adapt to track width

TPA 120

Total permitted weight:	kg	12.000
Bridge length	mm	5.200
Bridge width	mm	2.480
Platform height approx.	mm	1050 - 1170
Tyres		235/75R17,5"

Overloading trailer »VARIO«

Additional equipment options

- Rolling tarp operated from the ground
- Cardan shaft on one side, wide angle with friction clutch on tractor side
- FWS ISOBUS weighing device with printer
- Rear steering axle (starting from tandem)
- Fliegl Tracker system
- Overloading rate up to 10t/min.

Benefits

- Threshing efficiency is raised by up to 30%
- No harvester downtimes
- Perfect transport records with the Fliegl Tracker system



ULW 25 single-axle



ULW 30 with 30 m³ volume

Volume	approx. m ³
Total technical weight in the field	kg
Overloading height depending on tyres	approx. mm
Power requirement	HP
Tyres, others available as option	
Ø screw conveyor	mm
Overloading rate	t/min.



ULW 25 single-axle

ULW 25 tandem

ULW 30 tandem

ULW 40 tridem

ULW 45 tridem

25	25	30	40	45
16.000	26.000	26.000	34.000	34.000
4.300	4.300	4.300	4.300	4.300
from 120	from 160	from 200	from 250	from 300
28 L 26	550/60-22,5	600/55-26,5	600/55-26,5	650/50R22,5
420	420	420	420 / 520	420 / 520
7,5	7,5	7,5	7,5 / 10	7,5 / 10

Cattle transport trailer TTW »NOAH«

Greater safety for livestock transport

Benefits

- More safety for livestock transport with the non-slip checker plate floor
- Easier and gentler entry and exit for the animals with the hydraulic lifting gear
- Optionally with cover tarp
- 2-circuit compressed air with manual control
- Rubber floor (optional)
- Adjustable grid to separate individual animals
- 25km/h version with TÜV for Germany



Access doors front right as standard



Hydraulic lifting gear to assist entry and exit



Drift fence

		TTW 100	TTW 140
Total permitted weight	kg	10.000	14.000
Tongue load	kg	2.000	2.000
Bridge	mm	6.300 x 2.200 x 1.500	8.300 x 2.200 x 1.500
Tyres		385/55-R19,5	385/55-R19,5
Chassis		Single-axle	Tandem



The TTW 140 Tandem Noah livestock transport trailer has a total length of 8.3 m



TTW140 lowered



Chequer plate floor for animal safety



Fliegl Agrartechnik GmbH

Bürgermeister-Boch-Str. 1 | D-84453 Mühldorf a. Inn

Tel.: +49 (0) 86 31 307-0 | Fax: +49 (0) 86 31 307-550 | e-Mail: info@fliegl.com

Dimensions, weights, and technical data are subject to modification.

Some illustrations show special equipment.

Full catalogue 06-2023

